

Product Area Female cable connector, shieldable, solder M8 connectors

serie 768

Pole 4  
Article number 99 3362 00 04

illustration



scale drawing

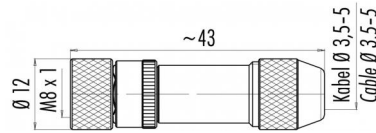

Contact Arrangement

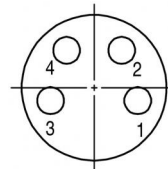

	X	Y
1	1,70	-0,50
2	1,08	1,45
3	-1,70	-0,50
4	-1,08	1,45

Attenuation characteristic

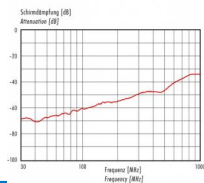
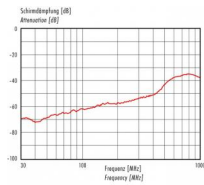

You can find the item description and assembly instruction on the next page.

Technical data

Common values

Connector Design	Female cable connector
Connector locking system	Screw
Termination	solder
Wire gauge (mm)	0,25 mm <sup>2</sup>
Wire gauge (AWG)	24
Cable outlet	3,5 - 5 mm
Upper temperature	+85 °C
Lower temperature	-40 °C

Material

Material of contact	CuSn (bronze)
Contact plating	Au (gold)
Material of contact body	PA (UL 94 HB)
Material of housing	CUZn (brass nickel plated)

Cable data

Contacts 4: Female cable connector, shieldable, solder

Electrical values

Rated voltage	30 V
Rated impulse voltage	800 V
Pollution degree	3
Overvoltage category	II
Material group	III
Rated current (40°C)	4 A
Volume resistivity	≤ 3 mΩ
Degree of protection	IP 67
Mechanical operation	>100 mating cycles



Product Area Female cable connector, shieldable, solder M8 connectors

serie 768

Pole 4  
Article number 99 3362 00 04

Item description

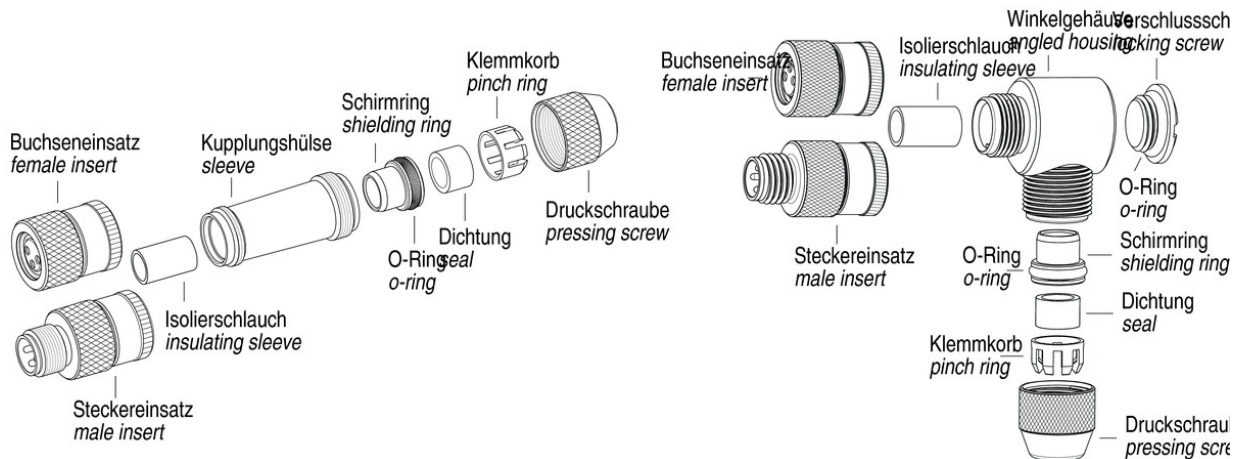

Installation instructions / Mounting cutout

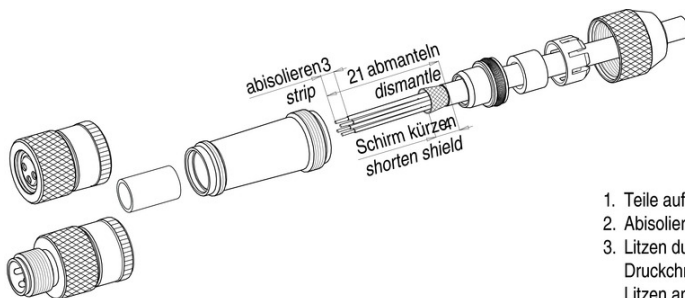

1. Teile auffädeln.
2. Abisolieren, Schirm kürzen, aufweiten und um Schirmring legen.
3. Litzen durch Gehäuse fädeln, Schirmring, Dichtring, Klemmkorb Druckschraube andrehen, um das Kabel zu fixieren. Isolierschlauch Litzen anlöten und Isolierschlauch montieren.
4. Gehäuse mit Stecker- bzw. Buchseneinsatz verschrauben und D festdrehen.
5. Bei Winkelversion Verschlusschraube anziehen.

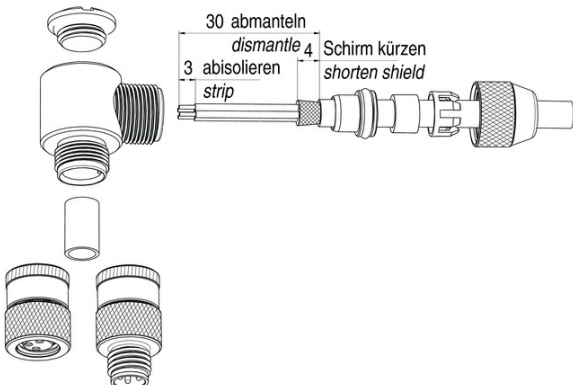

1. Bead parts on cable.
2. Strip, shorten, widen shield and lay around shielding ring.
3. Bead single wires through housing, mount shieldingring, sealing pinch ring. Slightly tighten pressing screw to fix the cable. Bead i tube, solder single wires and mount insulating tube.
4. Screw male or female contact carrier to housing and tighten pres
5. Angled version: tighten locking screw.

Product Female cable connector, shieldable, solder  
Area M8 connectors

serie 768

Pole 4  
Article number 99 3362 00 04

Date: 2014-07-20 - Page 3 of 3

Installation instructions / Mounting cutout

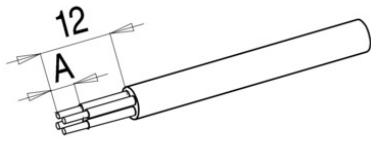

	Schraubklemmversion <i>screw connection</i>	Lötversion <i>solder version</i>
Maß A/mm <i>measure A/mm</i>	<b>4</b>	<b>3</b>