

Product	Male angled connector with UL approval, with die-cast threaded ring, cable gland 8 - 10 mm, 10 - 12 mm	Pole	4+PE
Area	7/8" connectors	serie 820	Article number 99 2445 63 05

illustration

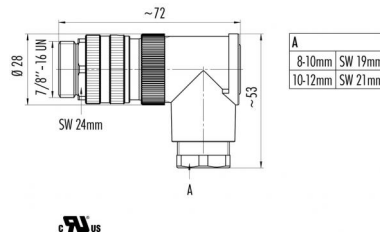

scale drawing



Contact Arrangement

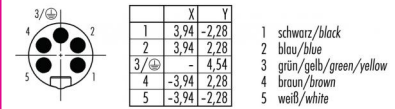

You can find the item description and assembly instruction on the next page.

Technical data

Common values

Connector Design	Male angled cable connector
Termination	screw
Cable outlet	8 - 10 mm
Upper temperature	+85 °C
Lower temperature	-25 °C

Material

Material of contact	CuZn (brass)
Contact plating	Au (gold)
Material of contact body	PUR, PA (UL 94 HB)
Material of housing	PBT (UL 94 V 0)

Electrical values

Rated voltage	300 V
Rated impulse voltage	4000 V
Pollution degree	3
Overvoltage category	III
Material group	III
Rated current (40°C)	9 A
Volume resistivity	≤ 3 mΩ
Degree of protection	IP 67
Mechanical operation	> 50 mating cycles

Cable data

material housing	-
insulation single lead	-
single lead structure	-
conductor resistance	-
bending radius cable fixed	-
bending radius cable movable	-

cable gland: 8 - 10 mm, number of pins: 4+PE, male angled connector with UL approval, conductor size 2.5 mm²



Product	Male angled connector with UL approval, with die-cast threaded ring, cable gland 8 - 10 mm, 10 - 12 mm	Pole	4+PE
Area	7/8" connectors	serie 820	Article number 99 2445 63 05

Item description

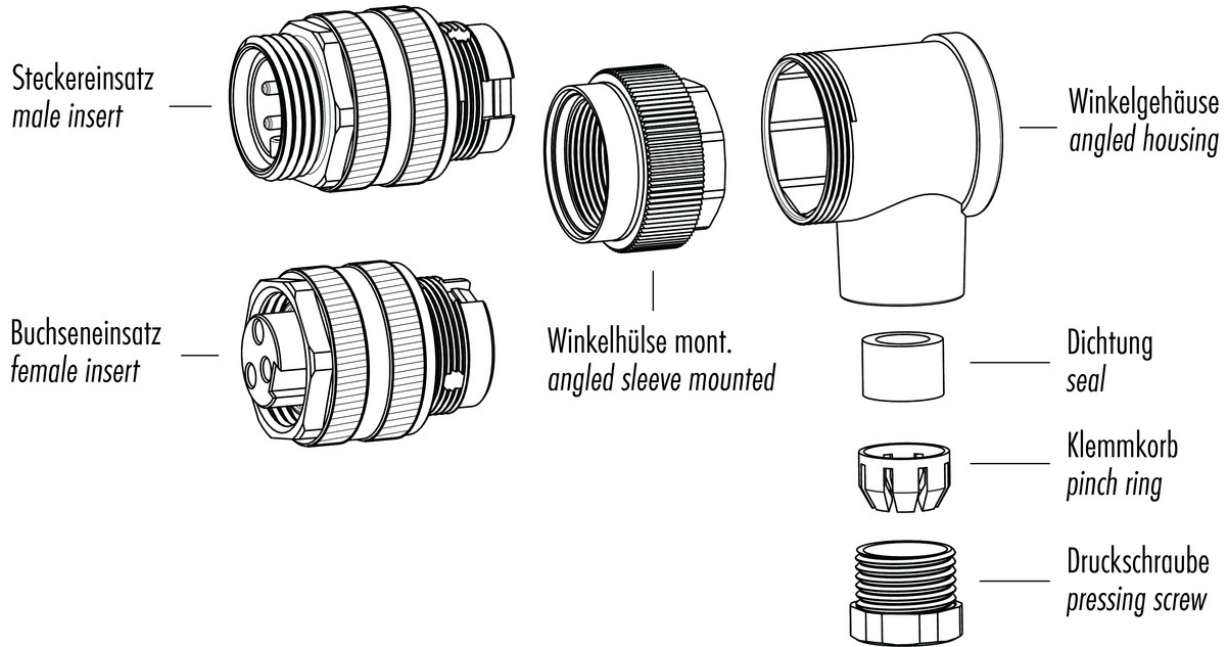

Installation instructions / Mounting cutout

