

Product Area	Female cable connector with UL approval, Cable outlet 8 - 10 mm, 12 - 14 mm, 7/8" connectors serie 820	Pole Article number	4+PE 99 2444 21 05
--------------	--	---------------------	--------------------

illustration

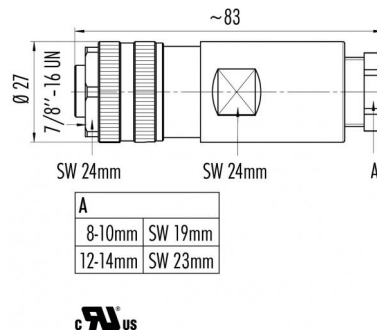

scale drawing



Contact Arrangement

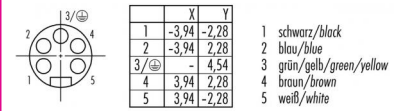

You can find the item description and assembly instruction on the next page.

Technical data

Common values

Connector Design	Female cable connector
Connector locking system	screw 7/8" - 16 UN
Termination	screw
Wire gauge (mm)	1,50 mm ²
Wire gauge (AWG)	16
Cable outlet	8 - 10 mm
Upper temperature	+85 °C
Lower temperature	-25 °C

Electrical values

Rated voltage	300 V
Rated impulse voltage	4000 V
Pollution degree	3
Overvoltage category	III
Material group	III
Rated current (40°C)	9 A
Volume resistivity	≤ 3 mΩ
EMV compliance	not shielded
Degree of protection	IP 67
Mechanical operation	> 50 mating cycles

Material

Material of contact	CuZn (brass)
Contact plating	Au (gold)
Material of contact body	PUR, PA (UL 94 HB)
Material of housing	PBT (UL 94 V 0)

Cable data

material housing	-
insulation single lead	-
single lead structure	-
conductor resistance	-
bending radius cable fixed	-
bending radius cable movable	-

Cable outlet: 8 - 10 mm, contacts: 4+PE, female cable connector with UL approval



Product Area	Female cable connector with UL approval, Cable outlet 8 - 10 mm, 12 - 14 mm, 7/8" connectors serie 820	Pole Article number	4+PE 99 2444 21 05
--------------	--	---------------------	--------------------

Item description

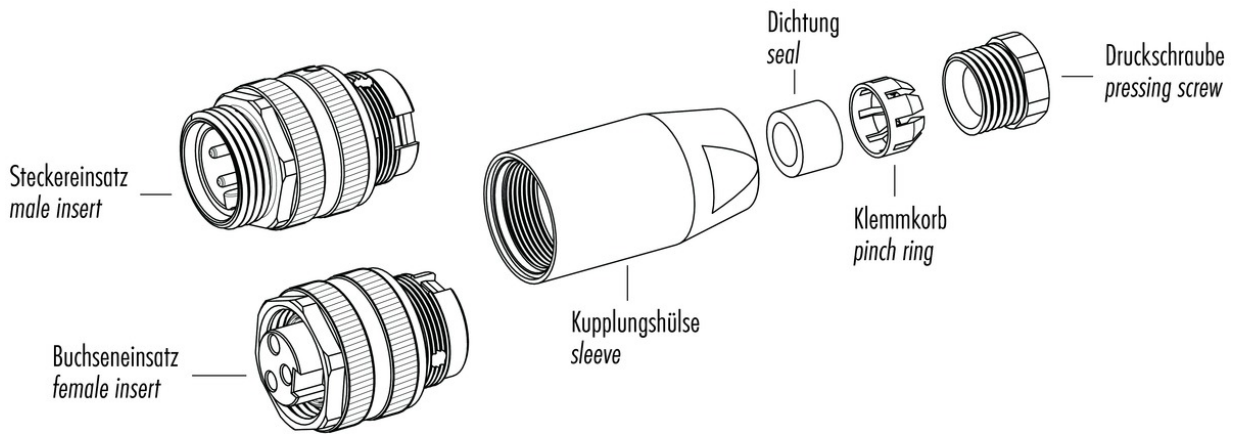

Installation instructions / Mounting cutout

