

Product Area	Female angled connector with UL approval 7/8" connectors	serie 820	Pole Article number	3+PE 99 2442 52 04
--------------	---	-----------	---------------------	-----------------------

illustration

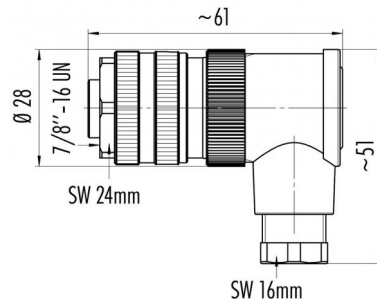

scale drawing



Contact Arrangement

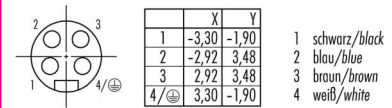

You can find the item description and assembly instruction on the next page.

Technical data

Common values

Connector Design	Female angled cable connector
Connector locking system	screw 7/8" - 16 UN
Termination	screw
Wire gauge (mm)	1,50 mm ²
Wire gauge (AWG)	16
Cable outlet	6 - 8 mm
Upper temperature	+85 °C
Lower temperature	-25 °C

Electrical values

Rated voltage	300 V
Rated impulse voltage	4000 V
Pollution degree	3
Overvoltage category	III
Material group	III
Rated current (40°C)	9 A
Volume resistivity	≤ 3 mΩ
EMV compliance	not shielded
Degree of protection	IP 67
Mechanical operation	> 50 mating cycles

Material

Material of contact	CuZn (brass)
Contact plating	Au (gold)
Material of contact body	PUR, PA (UL 94 HB)
Material of housing	PBT (UL 94 V 0)

Cable data

material housing	-
insulation single lead	-
single lead structure	-
conductor resistance	-
bending radius cable fixed	-
bending radius cable movable	-

Cable outlet: 6 - 8 mm, contacts: 3+PE, female angled connector, with UL approval



Product Area	Female angled connector with UL approval 7/8" connectors	serie 820	Pole Article number	3+PE 99 2442 52 04
--------------	---	-----------	---------------------	-----------------------

Item description

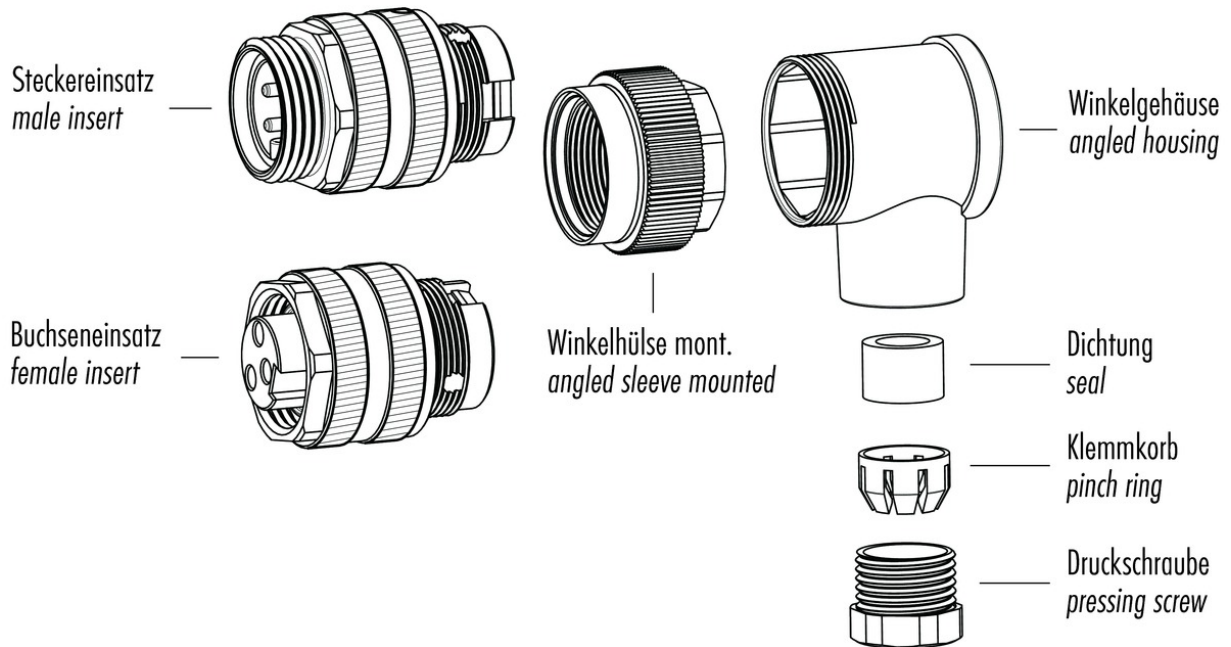

Installation instructions / Mounting cutout

