

Product	Male cable connector shieldable, with wire clamp connection, version with shielding ring, with Diecasted Zinc Thread Ring	Pole	5
Area	M12 connectors A-Coding	Article number	99 1537 814 05
	serie 713		

illustration

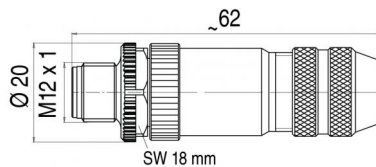

scale drawing



Contact Arrangement

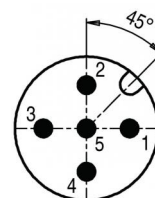

	X	Y
1	2,50	0,00
2	0,00	2,50
3	-2,50	0,00
4	0,00	-2,50
5	0,00	0,00

Attenuation characteristic

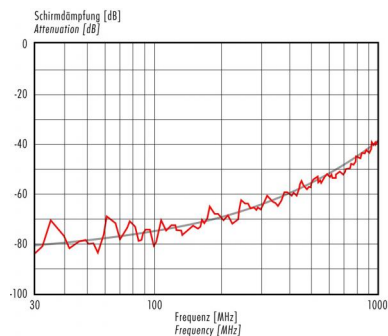

You can find the item description and assembly instruction on the next page.

Technical data

Common values

Connector Design	Male cable connector
Connector locking system	Screw
Termination	wire clamp
Wire gauge (mm)	0,50 mm ²
Wire gauge (AWG)	20
Cable outlet	4 - 6 mm
Upper temperature	+85 °C
Lower temperature	-40 °C

Material

Material of contact	CuSn (bronze)
Contact plating	Au (gold)
Material of contact body	PA
Material of housing	zinc diecasting, nickel plated

Cable data

Contacts 5: cable outlet: 4-6 mm, Male cable connector shieldable, with wire clamp connection, version with shielding ring, with Diecasted Zinc Thread Ring

Electrical values

Rated voltage	125 V
Rated impulse voltage	1500 V
Pollution degree	3
Overvoltage category	II
Material group	III
Rated current (40°C)	4 A
Volume resistivity	≤ 3 mΩ
Degree of protection	IP 67
Mechanical operation	>100 mating cycles



Product	Male cable connector shieldable, with wire clamp connection, version with shielding ring, with Diecasted Zinc Thread Ring	Pole	5
Area	M12 connectors A-Coding	serie 713	Article number 99 1537 814 05

Item description

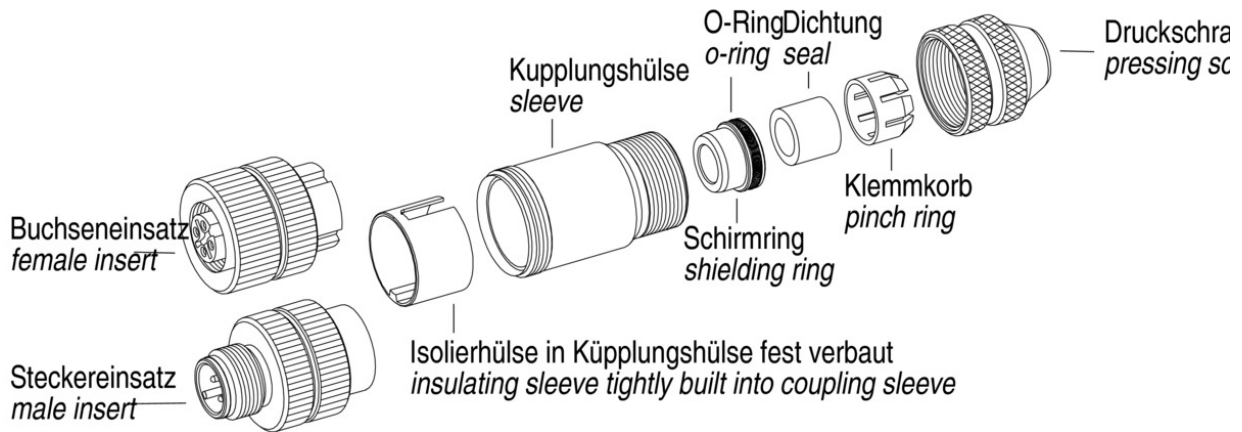

Installation instructions / Mounting cutout

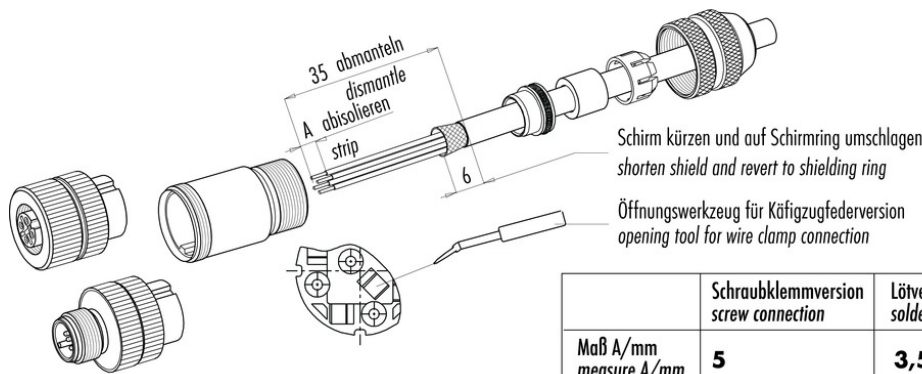

	Schraubklemmversion screw connection	Lötversion solder version	Käfigzugfederversion wire clamp connection
Maß A/mm measure A/mm	5	3,5	7