

Product	Female cable connector, shieldable, screw termination, iris type spring with Diecasted Zinc Thread Ring	Pole	5
Area	M12 connectors B-Coding	serie 715	Article number 99 1438 910 05

illustration

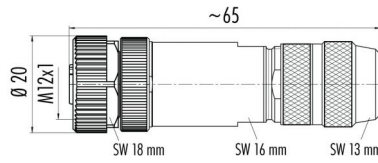

scale drawing



Contact Arrangement

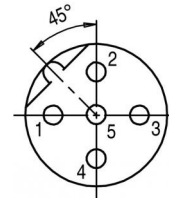

	X	Y
1	-2,50	0,00
2	0,00	2,50
3	2,50	0,00
4	0,00	-2,50
5	0,00	0,00

Attenuation characteristic

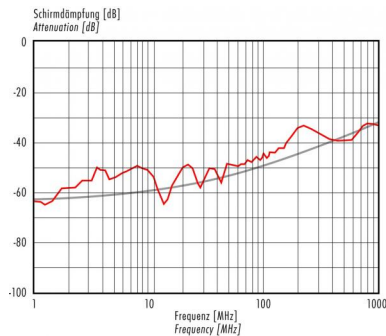

You can find the item description and assembly instruction on the next page.

Technical data

Common values

Connector Design	Female cable connector
Connector locking system	Screw
Wire gauge (mm)	0,75 mm ²
Wire gauge (AWG)	18
Upper temperature	+85 °C
Lower temperature	-40 °C

Material

Material of contact	CuZn (brass)
Contact plating	Au (gold)
Material of contact body	PA
Material of housing	PA/zinc diecasting, nickel plated, PA

Electrical values

Rated voltage	125 V
Rated impulse voltage	1500 V
Pollution degree	3
Overvoltage category	II
Material group	III
Rated current (40°C)	4 A
Volume resistivity	≤ 3 mΩ
Degree of protection	IP 67
Mechanical operation	>100 mating cycles

Cable data

material housing	-
insulation single lead	-
single lead structure	-
conductor resistance	-
bending radius cable fixed	-
bending radius cable movable	-

Cabel outlet: 8 - 9 mm, contacts: 5, female cable connector, shieldable, screw termination, iris type spring



Product	Female cable connector, shieldable, screw termination, iris type spring with Diecasted Zinc Thread Ring	Pole	5
Area	M12 connectors B-Coding serie 715	Article number	99 1438 910 05

Item description

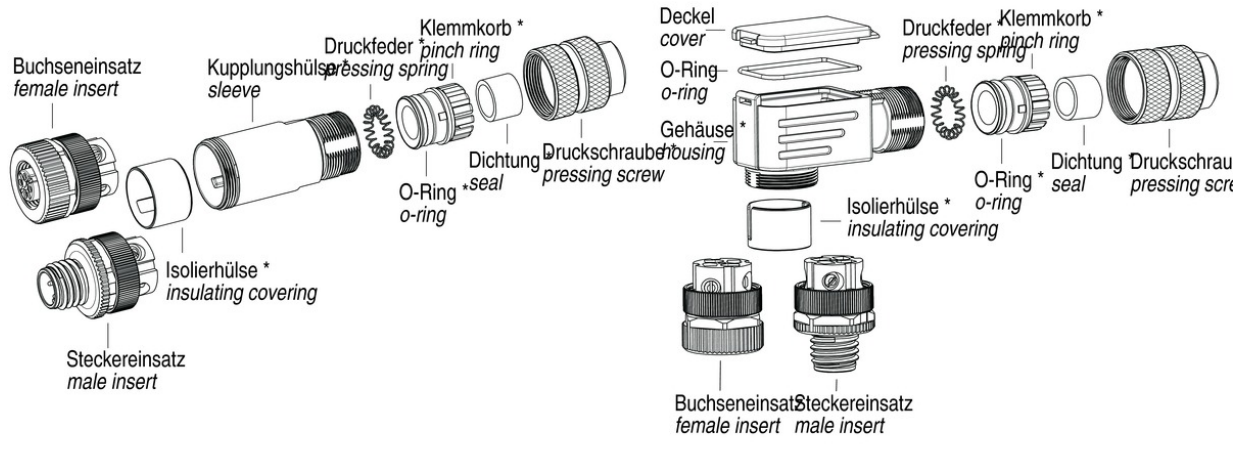

* Teile vormontiert
Premounted parts

Installation instructions / Mounting cutout

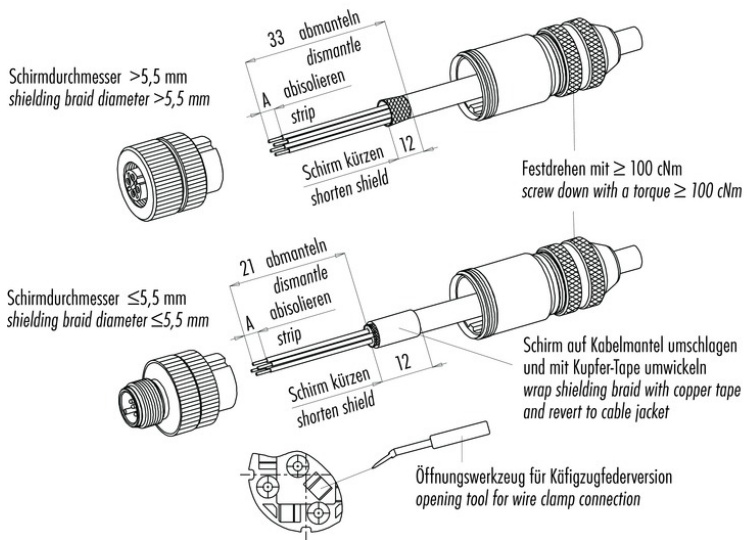

	Schraubklemmversion screw connection	Käfigzugfederversion wire clamp connection
Maß A/mm measure A/mm	5	7