

Product Female angled connector  
Area RD 30 connectors

serie 694

Pole 12+PE  
Article number 99 0718 72 13

**Deratingkurven**

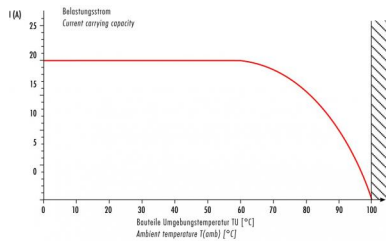

**illustration**



**scale drawing**

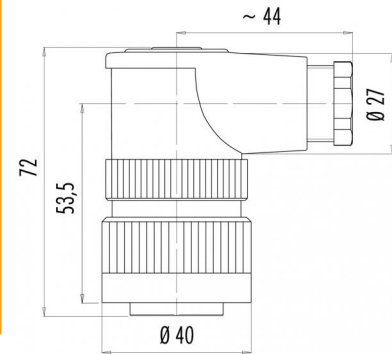

**Contact Arrangement**

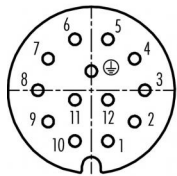

	X	Y
1	2,38	-7,33
2	6,23	-4,53
3	7,70	0,00
4	6,23	4,53
5	2,38	7,33
6	-2,38	7,33
7	-6,23	4,53
8	-7,70	0,00
9	-6,23	-4,53
10	-2,38	-7,33
11	-2,38	-1,37
12	2,38	-1,37
⊕	0,00	2,74

You can find the item description on the next page.

**Technical data**

**Common values**

Connector Design	Female angled cable connector
Connector locking system	Screw
Termination	solder
Wire gauge (mm)	1,00 mm <sup>2</sup>
Wire gauge (AWG)	18
Cable outlet	12 - 14 mm
Upper temperature	+100 °C
Lower temperature	-40 °C

**Material**

Material of contact	CuSn (bronze)
Contact plating	Ag (silver)
Material of contact body	PA (UL 94 HB)
Material of housing	PA (UL 94 V-0)

**Cable data**

Contacts 12+PE, female angled connector,  
Cable outlet 12 - 14 mm

**Electrical values**

Rated voltage	250 V
Rated impulse voltage	4000 V
Pollution degree	3
Overvoltage category	III
Material group	III
Rated current (40°C)	6 A
Volume resistivity	≤ 5 mΩ
EMV compliance	not shielded
Degree of protection	IP 65
Mechanical operation	>500 mating cycles

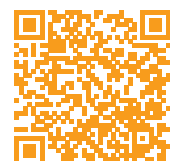

Product Area	Female angled connector RD 30 connectors	serie 694	Pole Article number	12+PE 99 0718 72 13
--------------	---	-----------	---------------------	------------------------

**Item description**

1. Winkelkappe, Winkelhülse, Dichtung, Klemmkorb und Druckschraube auffädeln.
2. Kontakteinsatz in Gehäuse einclipen.
3. Leiter abmanteln, absolieren und anschließen.
4. Winkelhülse mit vormontiertem Gehäuse bis zum mechanischen Anschlag fest verschrauben.
5. Teile gemäß Darstellung montieren.

1. Bead angled hood, sleeve, seal, pinch ring and pressing screw.
2. Clip contact insert into housing.
3. Dismantle cable, strip wire and contact wires.
4. Strongly fasten angled sleeve with preassembled housing up to mechanical stop.
5. Mount remaining parts according to figure.

