

Product Male angled connector, cable outlet 6-8 mm
Area Bayonet connectors

serie 678

Pole 6 DIN
Article number 99 0617 72 06

illustration



scale drawing

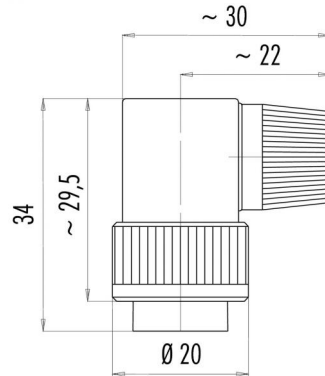

Contact Arrangement

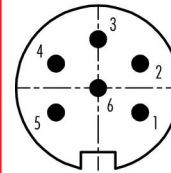

	X	Y
1	3,03	-1,75
2	3,03	1,75
3	0,00	3,50
4	-3,03	1,75
5	-3,03	-1,75
6	0,00	0,00

You can find the item description on the next page.

Technical data

Common values

Connector Design	Male angled cable connector
Connector locking system	BayonetHocking
Termination	solder
Wire gauge (mm)	0,75 mm ²
Wire gauge (AWG)	20
Cable outlet	6 - 8 mm
Upper temperature	+85 °C
Lower temperature	-40 °C

Material

Material of contact	CuZn (brass)
Contact plating	Ag (silver)
Material of contact body	PBT (UL 94 V-0)
Material of housing	PA (UL 94 V-0)

Cable data

Contacts 6 DIN, male angled connector, cable outlet 6 - 8 mm

Electrical values

Rated voltage	250 V
Rated impulse voltage	1500 V
Pollution degree	I
Overvoltage category	I
Material group	III
Rated current (40°C)	6 A
Volume resistivity	≤ 5 mΩ
EMV compliance	not shielded
Degree of protection	IP 40
Mechanical operation	>500 mating cycles



Product Male angled connector, cable outlet 6-8 mm
Area Bayonet connectors

serie 678

Pole 6 DIN
Article number 99 0617 72 06

Date: 2014-07-20 - Page 2 of 2

Item description

