

Product Area Male angled connector, metal locking system, screw termination
M12 connectors A-Coding serie 713

Pole 4
Article number 99 0429 52 04

illustration



scale drawing

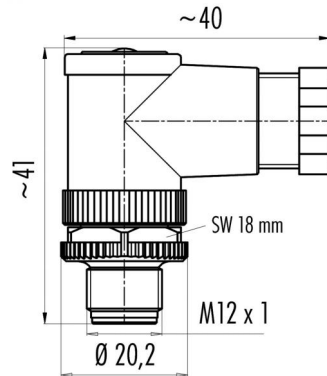

Contact Arrangement

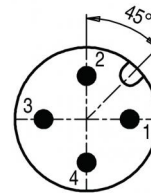

	X	Y
1	2,50	0,00
2	0,00	2,50
3	-2,50	0,00
4	0,00	-2,50

You can find the item description and assembly instruction on the next page.

Technical data

Common values

Connector Design	Male angled cable connector
Connector locking system	Screw
Termination	screw
Wire gauge (mm)	0,75 mm ²
Wire gauge (AWG)	18
Cable outlet	6 - 8 mm
Upper temperature	+85 °C
Lower temperature	-40 °C

Material

Material of contact	CuZn (brass)
Contact plating	CuSnZn (Optalloy)
Material of contact body	PA
Material of housing	PBT

Cable data

Contacts 4: cable outlet: 6-8 mm, Male angled connector, metal locking system, screw termination

Electrical values

Rated voltage	250 V
Rated impulse voltage	2500 V
Pollution degree	3
Overvoltage category	II
Material group	II
Rated current (40°C)	4 A
Volume resistivity	≤ 8 mΩ
Degree of protection	IP 67
Mechanical operation	> 50 mating cycles



Product Area Male angled connector, metal locking system, screw termination
M12 connectors A-Coding serie 713

Pole 4
Article number 99 0429 52 04

Item description



Installation instructions / Mounting cutout

