

Product Female angled connector, cable outlet 4-6 mm (.16-.24 in.)
Area M16 connectors IP 67 serie 723

Pole 7
Article number 99 0126 118 07

illustration



scale drawing

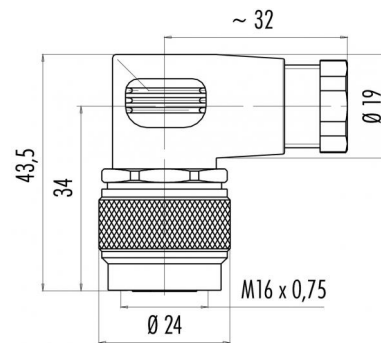

Contact Arrangement

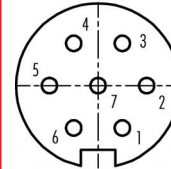

	X	Y
1	1,75	-3,03
2	3,50	0,00
3	1,75	3,03
4	-1,75	3,03
5	-3,50	0,00
6	-1,75	-3,03
7	0,00	0,00

You can find the item description on the next page.

Technical data

Common values

Connector Design	Female angled cable connector
Connector locking system	Screw
Termination	solder
Wire gauge (mm)	0,75 mm ²
Wire gauge (AWG)	20
Cable outlet	4 - 6 mm
Upper temperature	+95 °C
Lower temperature	-40 °C

Material

Material of contact	CuSn (bronze)
Contact plating	Au (gold)
Material of contact body	PBT (UL 94 V-0)
Material of housing	PA (UL 94 HB)

Cable data

Contacts 7, female angled connector, cable outlet 4 - 6 mm, gold plated contacts

Electrical values

Rated voltage	125 V
Rated impulse voltage	800 V
Pollution degree	1
Overvoltage category	I
Material group	III
Rated current (40°C)	5 A
Volume resistivity	≤ 3 mΩ
EMV compliance	not shielded
Degree of protection	IP 67
Mechanical operation	>500 mating cycles



Product Female angled connector, cable outlet 4-6 mm (.16-.24 in.)
Area M16 connectors IP 67 serie 723

Pole 7
Article number 99 0126 118 07

Date: 2014-07-20 - Page 2 of 2

Item description

