

Product	Connecting cable, connector for distribution -female cable connector M12, further parts can be added, lower part with fixing straps	Pole	2
Area	AS-Interface components	Article number	79 6420 20 02

illustration

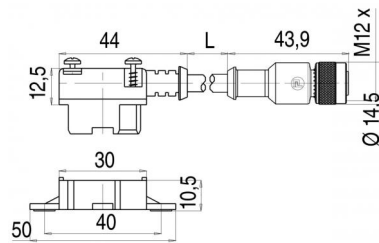

scale drawing



You can find the item description on the next page.

Technical data

Common values

Connector Design	flat cable clamp
Connector locking system	Connector for distribution
Wire gauge (mm)	1,50 mm ²
Wire gauge (AWG)	16
Upper temperature	+70 °C
Lower temperature	-25 °C

Material

Material of contact	CuZn (brass)
Contact plating	Sn (tin)/ Au (gold)
Material of contact body	PA
Material of housing	PA

Electrical values

Rated voltage	30 V
Pollution degree	3
Rated current (40°C)	2 A (per contact)
Volume resistivity	≤ 8 mΩ
Degree of protection	IP 67
Mechanical operation	Max. 10 mating cycles

Cable data

insulation single lead	-
single lead structure	-
bending radius cable fixed	-
bending radius cable movable	-
cable diameter	5.8

Cable length: 2 m, Contacts 2: Connecting cable, connector for distribution - female cable connector M12, further parts can be added, lower part with fixing straps

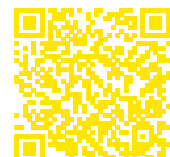

Product	Connecting cable, connector for distribution -female cable connector M12, further parts can be added, lower part with fixing straps	Pole	2
Area	AS-Interface components	Article number	79 6420 20 02

Item description

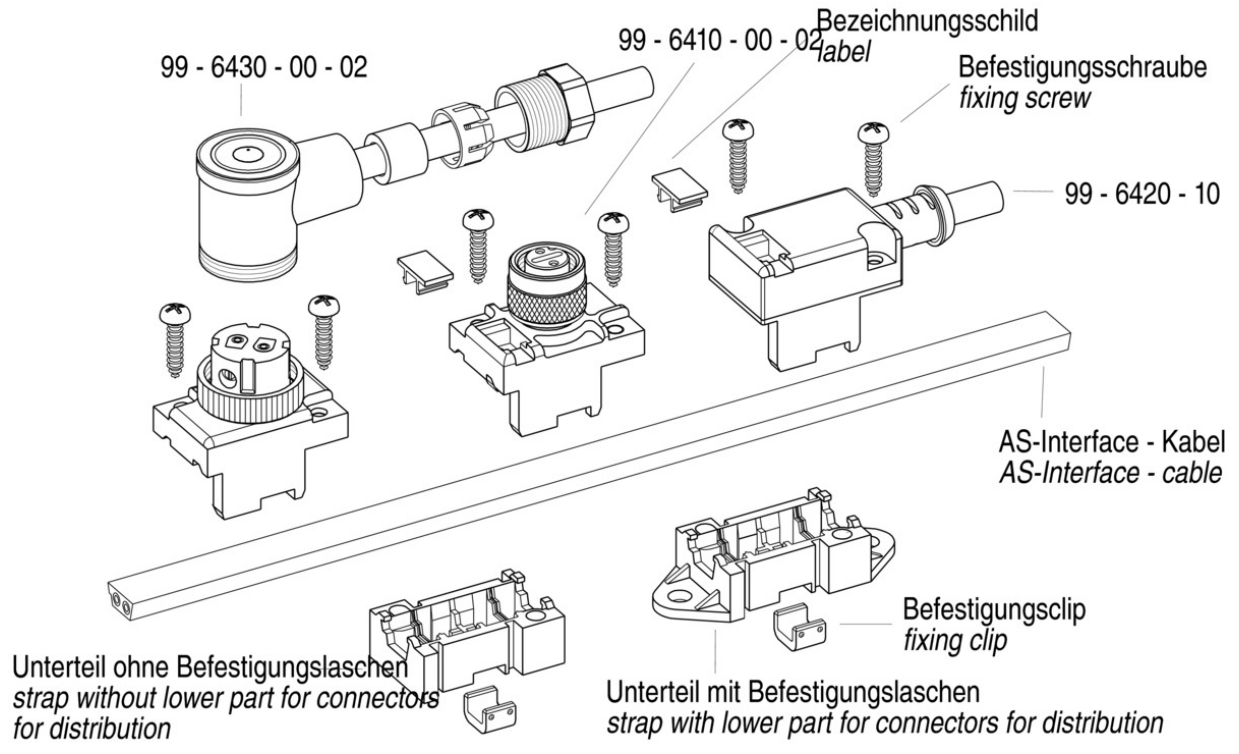

Item description

