

Product Area Female cable connector M12x 1 – female angled connector M12 x 1
Connecting cables - sensor connectors serie 765

Pole 4
Article number 79 5022 20 04

illustration



scale drawing

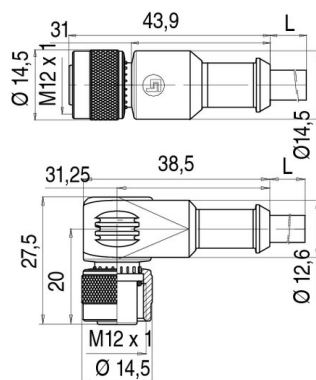

Contact Arrangement

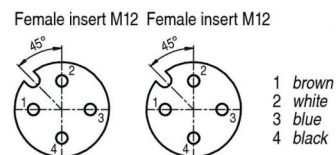

Technical data

Common values

Connector Design	Female cable connector - female angled connector
Connector locking system	Screw-locking
Termination	crimp, overmoulded on cable
Wire gauge (mm)	0,34 mm ²
Wire gauge (AWG)	22
Upper temperature	+85 °C
Lower temperature	-25 °C

Material

Material of contact	CuSn (bronze)
Contact plating	Au (gold)
Material of contact body	PUR
Material of housing	-

Cable data

Contacts 4: Cable length 2 m, Female cable connector M12x 1 – female angled connector M12 x 1, cable 4 x 0,34 PUR

Electrical values

Rated voltage	250 V
Rated impulse voltage	2500 V
Pollution degree	3
Overvoltage category	II
Material group	II
Rated current (40 °C)	4 A
Volume resistivity	≤ 3 mΩ
Degree of protection	IP 68
Mechanical operation	>100 mating cycles