

Product Area	female angled connector moulded, snap-in version, 8mm M8 connectors serie 718	Pole	3
		Article number	79 3414 45 03

illustration

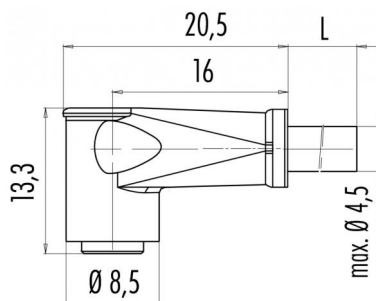

scale drawing



Contact Arrangement

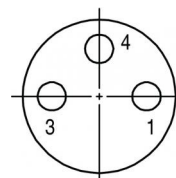

- 1 braun/brown
- 3 blau/blue
- 4 schwarz/blac

Technical data

Common values

Connector Design	Female angled cable connector
Connector locking system	Snap-in locking
Termination	crimp, overmoulded on cable
Wire gauge (mm)	0,25 mm ²
Wire gauge (AWG)	24
Cable outlet	-
Upper temperature	+70 °C
Lower temperature	-25 °C

Electrical values

Rated voltage	60 V
Rated impulse voltage	800 V
Pollution degree	3
Overvoltage category	II
Material group	II
Rated current (40°C)	4 A
Volume resistivity	≤ 3 mΩ
Degree of protection	IP 65
Mechanical operation	> 50 mating cycles

Material

Material of contact	CuSn (bronze)
Contact plating	Au (gold)
Material of contact body	PUR
Material of housing	PUR

Cable data

material housing	PVC
insulation single lead	PVC
single lead structure	32 x 0,1
cable sheath Ø	4.5
conductor resistance	79,5Ω/Km
temperature range cable movable c from	-5
temperature range cable movable c to	70
temperature range cable fixed c from	-15
temperature range cable fixed c to	70
bending radius cable fixed	min. 5 x D
bending radius cable movable	min. 10 x D

Contacts 3, cable: 5 m, 3 x 0,25 PVC, Male angled connector moulded, snap-in version, 8mm

