

Product Male angled connector moulded, screw version, M8x1
Area M8 connectors serie 718

Pole 3
Article number 79 3407 55 03

illustration



scale drawing

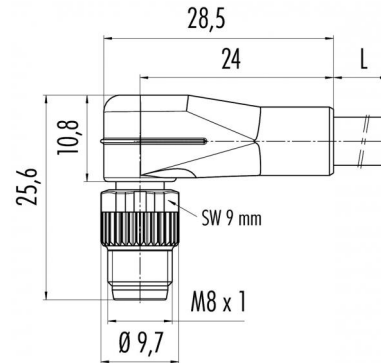

Contact Arrangement

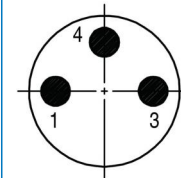

1 braun/brown
3 blau/blue
4 schwarz/blac

Technical data

Common values

Connector Design	Male cable connector
Termination	crimp, overmoulded on cable
Wire gauge (mm)	0,25 mm ²
Wire gauge (AWG)	24
Upper temperature	+85 °C
Lower temperature	-25 °C

Electrical values

Rated voltage	60 V
Rated impulse voltage	800 V
Pollution degree	3
Overvoltage category	II
Material group	II
Rated current (40°C)	4 A
Volume resistivity	≤ 3 mΩ
Degree of protection	IP 67
Mechanical operation	>100 mating cycles

Material

Material of contact	CuZn (brass)
Contact plating	Au (gold)
Material of contact body	PUR
Material of housing	PUR

Cable data

material housing	PUR
insulation single lead	PVC
single lead structure	32 x 0,1
cable sheath Ø	4.5
conductor resistance	72Ω/Km
temperature range cable movable c from	-5
temperature range cable movable c to	70
temperature range cable fixed c from	-15
temperature range cable fixed c to	70
bending radius cable fixed	min. 5 x D
bending radius cable movable	min. 10 x D
approval	-



Polzahl: 3, Kabellänge 5 m, Kabel: 3 x 0,25
PUR, Winkelstecker umspritzt, Schraubversion
M8 x 1