

Product Male angled connector moulded, M5 x 0,5
Area M5 connectors

serie 707

Pole 3
Article number 79 3103 35 03

illustration



scale drawing

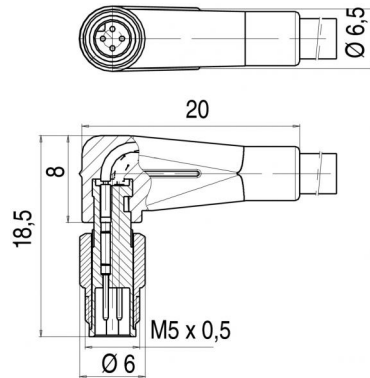

Contact Arrangement



	X	Y
1	-0,63	-0,63
2	-	-
3	0,63	0,63
4	-0,63	0,63

- 1 braun / brown
- 2 nicht kontaktiert / not assembled
- 3 blau / blue
- 4 schwarz / black

Technical data

Common values

Connector Design	Male angled cable connector
Connector locking system	Screw
Termination	crimp, overmoulded on cable
Wire gauge (mm)	0,25 mm ²
Wire gauge (AWG)	24
Cable outlet	-
Upper temperature	+80 °C
Lower temperature	-25 °C

Electrical values

Rated voltage	60 V
Rated impulse voltage	800 V
Pollution degree	3
Overvoltage category	II
Material group	I
Rated current (40°C)	1 A
Volume resistivity	≤ 3 mΩ
Degree of protection	IP 67
Mechanical operation	>100 mating cycles

Material

Material of contact	CuZn (brass)
Contact plating	Au (gold)
Material of contact body	PUR
Material of housing	PUR

Cable data

material housing	PUR
insulation single lead	PVC
single lead structure	32 x 0,1
cable sheath Ø	3,7
conductor resistance	148Ω/Km
temperature range cable movable c from	-5
temperature range cable movable c to	80
temperature range cable fixed c from	-25
temperature range cable fixed c to	80

Contacts 3: cable 5 m, 3 x 0,25 mm² PUR,
Male angled connector moulded, M5 x 0,5

