

Product Area	Male angled connector 7/8" connectors	serie 870	Pole	3
			Article number	79 2455 20 03

illustration

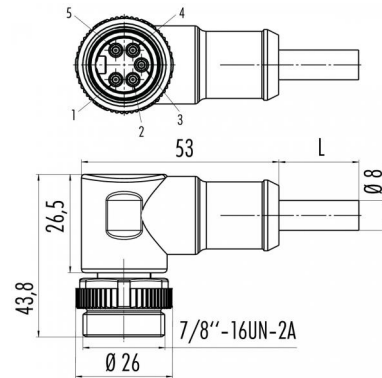

scale drawing



Contact Arrangement



Technical data

Common values

Connector Design	Male angled cable connector
Connector locking system	screw 7/8" - 16 UN
Termination	crimp
Wire gauge (mm)	1,50 mm ²
Wire gauge (AWG)	16
Upper temperature	+85 °C
Lower temperature	-25 °C

Electrical values

Rated voltage	300 V
Rated impulse voltage	4000 V
Pollution degree	3
Overvoltage category	II
Material group	II
Rated current (40°C)	12 A
Volume resistivity	≤ 3 mΩ
EMV compliance	-
Degree of protection	IP 68
Mechanical operation	>100 mating cycles

Material

Material of contact	CuZn (brass)
Contact plating	Au (gold)
Material of contact body	PUR
Material of housing	PUR

Cable data

material housing	PUR
insulation single lead	TPM
single lead structure	82 x 0,15 mm
cable sheath Ø	7.4
conductor resistance	-
temperature range cable movable c from	-20
temperature range cable movable c to	80
temperature range cable fixed c from	-50
temperature range cable fixed c to	80
bending radius cable fixed	-
bending radius cable movable	7,5 x d

Cabel: 3 x 1,5 PUR, contacts: 3, male angled connector, cabel length: 2 m

