

Product Area Male angled connector overmoulded, unshielded
M9 connectors IP 67 serie 702

Pole 8
Article number 79 1461 275 08

illustration



scale drawing

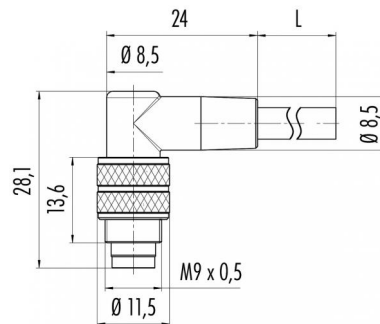

Contact Arrangement

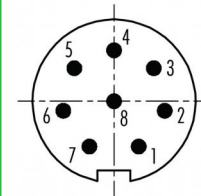

- 1 weiß/white
- 2 braun/brown
- 3 grün/green
- 4 gelb/yellow
- 5 grau/grey
- 6 rosa/pink
- 7 blau/blue
- 8 rot/red

Technical data

Common values

Connector Design	Male angled cable connector
Termination	moulded on cable
Wire gauge (mm)	0,14 mm ²
Wire gauge (AWG)	26
Cable outlet	-
Upper temperature	+70 °C
Lower temperature	-25 °C

Electrical values

Rated voltage	125 V
Rated impulse voltage	1500 V
Pollution degree	I
Overvoltage category	II
Material group	III
Rated current (40°C)	1 A
Volume resistivity	≤ 3 mΩ
Degree of protection	IP 67
Mechanical operation	>500 mating cycles

Material

Material of contact	CuZn (brass)
Contact plating	Au (gold)
Material of contact body	PBT (UL 94 V-0)
Material of housing	PUR

Cable data

material housing	PUR
insulation single lead	PVC/PE
single lead structure	18 x 0,10 mm
cable sheath Ø	5
conductor resistance	117 Ω/km
temperature range cable movable c from	-5
temperature range cable movable c to	70
temperature range cable fixed c from	-25
temperature range cable fixed c to	70
bending radius cable fixed	Min. 25 mm
bending radius cable movable	Min. 50 mm

Number of pins: 8, male angled connector overmoulded, unshielded, cable length 5 m

