

Product Male angled connector, moulded, shieldable
Area M9 connectors IP 67

serie 702

Pole 5
Article number 79 1413 75 05

illustration



scale drawing

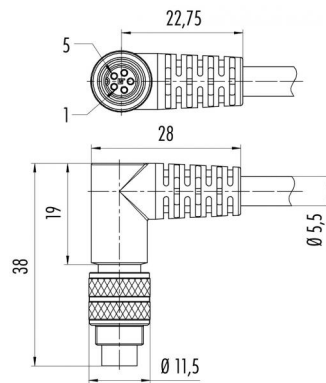

Contact Arrangement

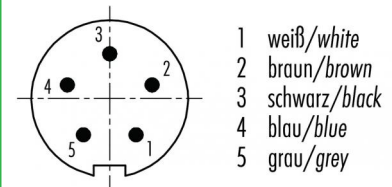

Technical data

Common values

Connector Design	Male angled cable connector
Connector locking system	Screw
Termination	moulded on cable
Wire gauge (mm)	0,25 mm ²
Wire gauge (AWG)	24
Cable outlet	-
Upper temperature	+70 °C
Lower temperature	-25 °C

Electrical values

Rated voltage	125 V
Rated impulse voltage	1500 V
Pollution degree	I
Overvoltage category	II
Material group	III
Rated current (40°C)	3 A
Volume resistivity	≤ 3 mΩ
EMV compliance	shielded
Degree of protection	IP 67
Mechanical operation	>500 mating cycles

Material

Material of contact	CuZn (brass)
Contact plating	Au (gold)
Material of contact body	PBT (UL 94 V-0)
Material of housing	PUR

Cable data

material housing	PUR
insulation single lead	PVC
single lead structure	1.4 x 0,15 mm
cable sheath Ø	5.3
conductor resistance	75Ω/Km
bending radius cable fixed	Min. 53 mm
bending radius cable movable	Min. 80 mm
cable diameter	5.3

Contacts 5, Male angled connector, moulded, shielded, Cable length 5 m

