

Product Area Female angled connector, moulded, shieldable
M9 connectors IP 67 serie 702

Pole 2
Article number 79 1402 72 02

illustration



scale drawing

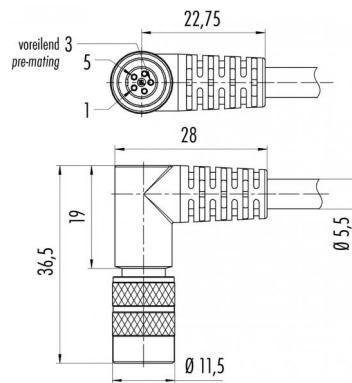

Contact Arrangement

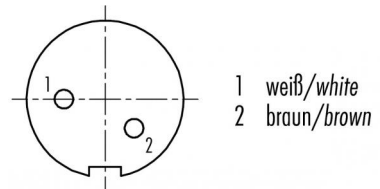

Technical data

Common values

Connector Design	Female angled cable connector
Connector locking system	Screw
Termination	moulded on cable
Wire gauge (mm)	0,25 mm ²
Wire gauge (AWG)	24
Cable outlet	-
Upper temperature	+70 °C
Lower temperature	-25 °C

Electrical values

Rated voltage	125 V
Rated impulse voltage	1500 V
Pollution degree	I
Overvoltage category	II
Material group	III
Rated current (40°C)	4 A
Volume resistivity	≤ 3 mΩ
EMV compliance	shielded
Degree of protection	IP 67
Mechanical operation	>500 mating cycles

Material

Material of contact	CuSn (bronze)
Contact plating	Au (gold)
Material of contact body	PBT (UL 94 V-0)
Material of housing	PUR

Cable data

material housing	PUR
insulation single lead	PVC
single lead structure	1.4 x 0,15 mm
cable sheath Ø	5.3
conductor resistance	75Ω/Km
bending radius cable fixed	Min. 53 mm
bending radius cable movable	Min. 80 mm
cable diameter	5.3

Contacts 2, Female angled connector, moulded, shielded, Cable length 2 m

