

Product Area Male power connector DIN EN 175301-803, rectangular, radius, with UL approval, SEV serie 210/A

Pole Article number 3+PE 43 1719 026 04

illustration



scale drawing

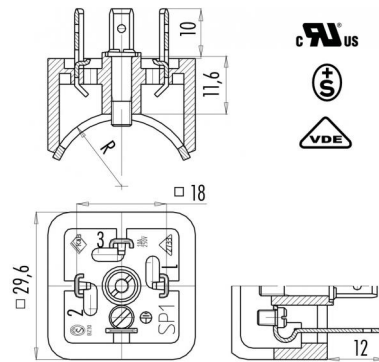

Technical data

Common values

Connector Design	Male Connector
Connector locking system	central screw
Termination	solder
Wire gauge (mm)	1,00 mm ²
Wire gauge (AWG)	18
Upper temperature	+100 °C
Lower temperature	-20 °C

Electrical values

Rated voltage	250 V
Rated impulse voltage	4000 V
Pollution degree	3
Overvoltage category	III
Material group	III
Rated current (40°C)	10 A
Volume resistivity	≤ 15 mΩ
EMV compliance	not shielded
Degree of protection	IP 65
Mechanical operation	> 50 mating cycles

Material

Material of contact	CuZn (brass)
Contact plating	Sn (tin)
Material of contact body	PA (UL 94 HB)
Material of housing	-

Cable data

material housing	-
insulation single lead	-
single lead structure	-
conductor resistance	-
bending radius cable fixed	-
bending radius cable movable	-

Contacts: 3+PE, Male power connector DIN EN 175301-803, rectangular, radius 31 mm

