

Product Female power connector DIN EN 175301-803, high housing, with 6,3 mm fast-on crimp contacts
Area Size A serie 210/A

Pole 3+PE
Article number 43 1708 017 00

illustration



scale drawing

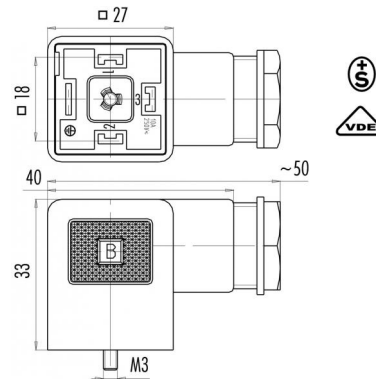

Contact Arrangement

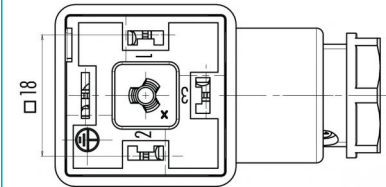

You can find the item description on the next page.

Technical data

Common values

Connector Design	female connector
Connector locking system	central screw
Termination	crimp
Cable outlet	8 - 10 mm
Upper temperature	+120 °C
Lower temperature	-30 °C

Material

Material of contact	CuSn (bronze)
Contact plating	Ni (nickel)
Material of contact body	PA (UL 94 HB)
Material of housing	PA (UL 94 HB)

Electrical values

Rated voltage	250 V
Rated impulse voltage	4000 V
Pollution degree	3
Overvoltage category	III
Material group	III
Rated current (40°C)	10 A
Volume resistivity	≤ 15 mΩ
EMV compliance	not shielded
Degree of protection	IP 65
Mechanical operation	> 50 mating cycles

Cable data

material housing	-
insulation single lead	-
single lead structure	-
conductor resistance	-
bending radius cable fixed	-
bending radius cable movable	-

Contacts: 3+PE, Female power connector DIN EN 175301-803, high housing, with 6,3 mm fast-on crimp contacts, Cable outlet 8 - 10 mm, Wire 1,0 mm²

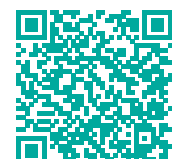

Product	Female power connector DIN EN 175301-803, high housing, with 6,3 mm fast-on crimp contacts
Area	Size A serie 210/A

Pole	3+PE
Article number	43 1708 017 00

Item description

