

Product Area	Female power connector DIN EN 175301-803, high housing, Cable outlet 8 - 10 mm Size A serie 210/A	Pole Article number	2+PE 43 1704 002 03
--------------	---	---------------------	------------------------

illustration

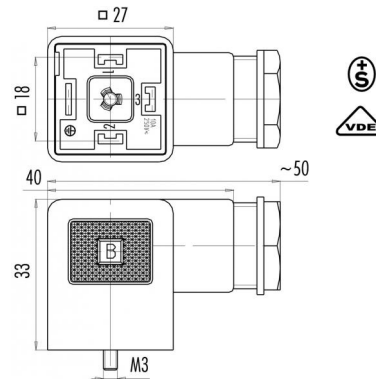

scale drawing



Contact Arrangement

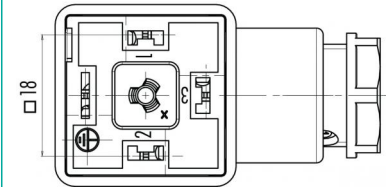

You can find the item description on the next page.

Technical data

Common values

Connector Design	female connector
Connector locking system	central screw
Termination	screw
Wire gauge (mm)	min. 0.34 mm ² , max. 1.5 mm ²
Wire gauge (AWG)	min. AWG 22, max. AWG 16
Cable outlet	8 - 10 mm
Upper temperature	+120 °C
Lower temperature	-30 °C

Electrical values

Rated voltage	250 V
Rated impulse voltage	4000 V
Pollution degree	3
Overvoltage category	III
Material group	III
Rated current (40°C)	10 A
Volume resistivity	≤ 15 mΩ
Degree of protection	IP 65
Mechanical operation	> 50 mating cycles

Material

Material of contact	CuSn (bronze)
Contact plating	Ni (nickel)
Material of contact body	PA (UL 94 HB)
Material of housing	PA (UL 94 HB)

Cable data

material housing	-
insulation single lead	-
single lead structure	-
conductor resistance	-
bending radius cable fixed	-
bending radius cable movable	-

Contacts: 2+PE, Female power connector DIN EN 175301-803, high housing, Cable outlet 8 - 10 mm



Product Area Female power connector DIN EN 175301-803, high housing, Cable outlet 8 - 10 mm
Size A serie 210/A

Pole 2+PE
Article number 43 1704 002 03

Date: 2014-07-20 - Page 2 of 2

Item description

