

Product Area	Female socket with wires AWG 18, with UL approval 7/8" connectors	serie 820/870	Pole Article number	4+PE 09 2450 310 05
--------------	--	---------------	---------------------	------------------------

illustration

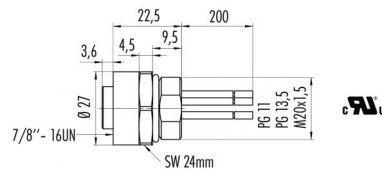

scale drawing



Contact Arrangement

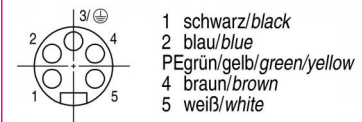

You can find the assembly instruction on the next page.

Technical data

Common values

Connector locking system	screw 7/8" - 16 UN
Wire gauge (mm)	0,82 mm <sup>2</sup>
Wire gauge (AWG)	18
Upper temperature	+85 °C
Lower temperature	-25 °C

Material

Material of contact	CuZn (brass)
Contact plating	Au (gold)
Material of contact body	PUR (UL 94 HB)
Material of housing	brass, zinc diecasting, nickel plated

Electrical values

Rated voltage	300 V
Rated impulse voltage	2500 V
Pollution degree	3
Overvoltage category	III
Material group	III
Rated current (40°C)	8 A
Volume resistivity	≤ 5 mΩ
Degree of protection	IP 67
Mechanical operation	> 50 mating cycles

Cable data

material housing	-
insulation single lead	-
single lead structure	-
conductor resistance	-
bending radius cable fixed	-
bending radius cable movable	-

Fixing thread: PG 11, contacts: 4+PE, female socket with wires AWG 18, with UL approval

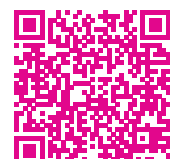

Product Female socket with wires AWG 18, with UL approval  
Area 7/8" connectors serie 820/870

Pole 4+PE  
Article number 09 2450 310 05

Date: 2014-07-20 - Page 2 of 2

Installation instructions / Mounting cutout

Mit Durchgangsbohrung/With bore hole

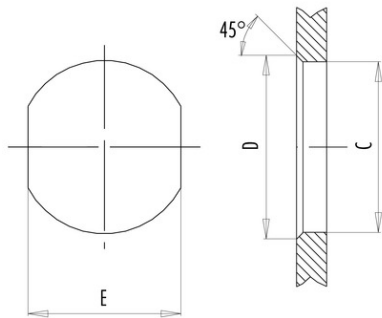

alternativ/alternativ

Mit Gewinde, einschraubbar/With thread to screw in

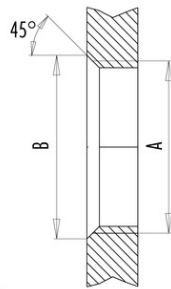

	A	B	C	D	E
PG11	PG11	20,2	18,7	20,2	17,0
PG13,5	PG13,5	22,0	20,5	22,0	18,8
M20x1,5	M20x1,5	21,6	20,1	21,6	17,8

Mit Durchgangsbohrung/With bore hole  
von vorn verschraubbar/front fastened

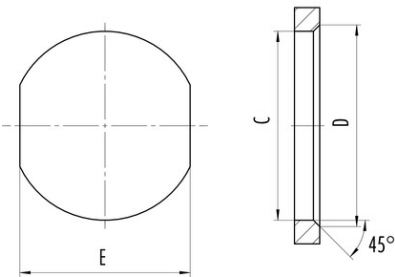

alternativ/alternativ

Mit Gewinde, einschraubbar/With thread to screw in

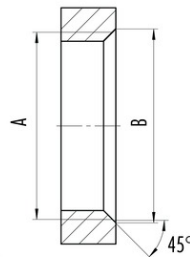

A	B	C	D	E
7/8-16UN-20	23	22,4	23,9	20,2
M26x1,5	27,3	26,2	27,7	24,2