

Product Area	Flanschdose, von vorn verschraubbar, Tauchlötkontakte 7/8" connectors	serie 820/870	Pole	4
			Article number	09 2448 180 04

illustration

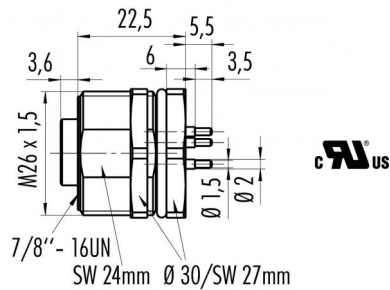

scale drawing



Contact Arrangement

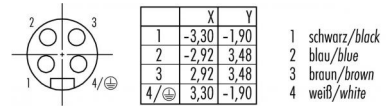

You can find the assembly instruction on the next page.

Technical data

Common values

Connector Design	Female socket
Wire gauge (mm)	-
Wire gauge (AWG)	-
Cable outlet	-
Upper temperature	+85 °C
Lower temperature	-25 °C

Material

Material of contact	CuZn (brass)
Contact plating	Au (gold)
Material of contact body	PUR (UL 94 HB)
Material of housing	zinc diecasting, nickel plated / brass nickel plated

Electrical values

Rated voltage	600 V
Rated impulse voltage	2500 V
Pollution degree	3
Overvoltage category	III
Material group	III
Rated current (40°C)	8 A
Volume resistivity	≤ 5 mΩ
Degree of protection	IP 67
Mechanical operation	>100 mating cycles

Cable data

material housing	-
insulation single lead	-
single lead structure	-
conductor resistance	-
bending radius cable fixed	-
bending radius cable movable	-
approval	UL

Polzahl: 4, Flanschdose, von vorn verschraubbar, Tauchlötkontakt

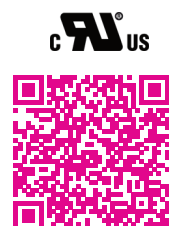

Product Flanschdose, von vorn verschraubbar, Tauchlötkontakte
Area 7/8 " connectors serie 820/870

Pole 4
Article number 09 2448 180 04

Installation instructions / Mounting cutout

Mit Durchgangsbohrung/With bore hole

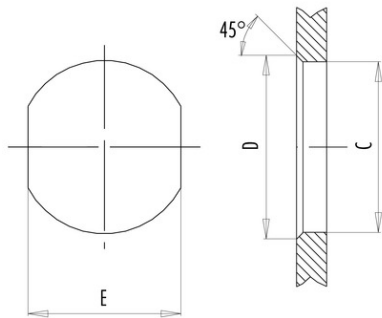

alternativ/alternativ

Mit Gewinde, einschraubbar/With thread to screw in

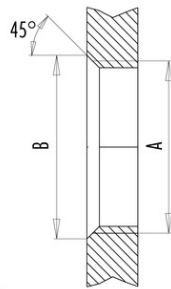

	A	B	C	D	E
PG11	PG11	20,2	18,7	20,2	17,0
PG13,5	PG13,5	22,0	20,5	22,0	18,8
M20x1,5	M20x1,5	21,6	20,1	21,6	17,8

Mit Durchgangsbohrung/With bore hole
von vorn verschraubbar/front fastened

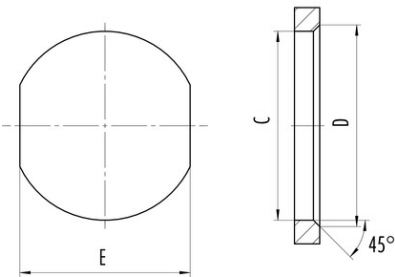

alternativ/alternativ

Mit Gewinde, einschraubbar/With thread to screw in

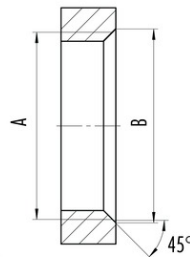

A	B	C	D	E
7/8-16UN-20	23	22,4	23,9	20,2
M26x1,5	27,3	26,2	27,7	24,2