

Product Area Female socket, solder, front fastened
M9 connectors IP 67

serie 712/702

Pole 5
Article number 09 0416 80 05

illustration



scale drawing

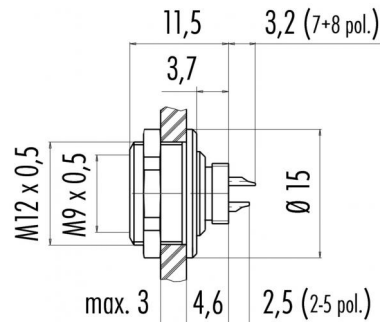

Contact Arrangement

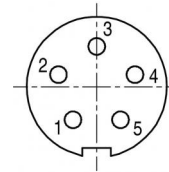

	X	Y
1	-1,00	-1,37
2	-1,61	0,52
3	0,00	1,70
4	1,61	0,52
5	1,00	-1,37

You can find the assembly instruction on the next page.

Technical data

Common values

Connector Design	Female socket
Connector locking system	Screw
Termination	solder
Wire gauge (mm)	0,25 mm ²
Wire gauge (AWG)	24
Cable outlet	-
Upper temperature	+85 °C
Lower temperature	-40 °C

Electrical values

Rated voltage	125 V
Rated impulse voltage	1500 V
Pollution degree	I
Overvoltage category	II
Material group	III
Rated current (40°C)	3 A
Volume resistivity	≤ 3 mΩ
EMV compliance	shieldable
Degree of protection	IP 67
Mechanical operation	>500 mating cycles

Material

Material of contact	CuSn (bronze)
Contact plating	Au (gold)
Material of contact body	PA (UL 94 V-0)
Material of housing	CUZn (brass nickel plated)

Cable data

material housing	-
insulation single lead	-
single lead structure	-
conductor resistance	-

Contacts 5, Female socket, solder, front fastened



Product Area Female socket, solder, front fastened
M9 connectors IP 67

serie 712/702

Pole 5
Article number 09 0416 80 05

Date: 2014-07-20 - Page 2 of 2

Installation instructions / Mounting cutout

