

Product Male socket, dip solder, front fastened with shielding sheet 6 mm
Area M9 connectors IP 67 serie 712/702

Pole 4
Article number 09 0411 30 04

illustration



You can find the assembly instruction on the next page.

Conductor layout

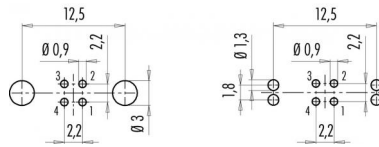

scale drawing

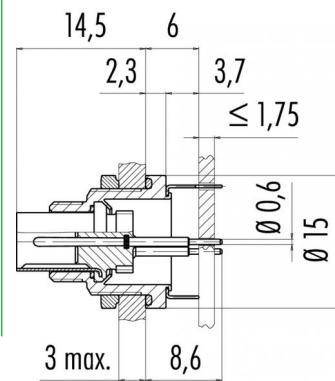

Technical data

Common values

Connector Design	Male socket
Connector locking system	Screw
Termination	dip solder
Wire gauge (mm)	-
Wire gauge (AWG)	-
Cable outlet	-
Upper temperature	+85 °C
Lower temperature	-40 °C

Electrical values

Rated voltage	125 V
Rated impulse voltage	1500 V
Pollution degree	I
Overvoltage category	II
Material group	III
Rated current (40°C)	3 A
Volume resistivity	$\le 3 \text{ m}\Omega$
EMV compliance	shieldable
Degree of protection	IP 67
Mechanical operation	>500 mating cycles

Material

Material of contact	CuZn (brass)
Contact plating	Au (gold)
Material of contact body	PA (UL 94 V-0)
Material of housing	CUZn (brass nickel plated)

Cable data

material housing	-
insulation single lead	-
single lead structure	-
conductor resistance	-

Contacts 4, Male socket, dip solder, front fastened with shielding sheet 6 mm



Product Male socket, dip solder, front fastened with shielding sheet 6 mm
Area M9 connectors IP 67 serie 712/702

Pole 4
Article number 09 0411 30 04

Date: 2014-07-20 - Page 2 of 2

Installation instructions / Mounting cutout

