

Product Flanschstecker mit Flexplatte, von vorn verschraubbar, vergoldete Kontakte, zweireihig
Area M16 connectors IP 67 serie 423/ 723/ 425

Pole 12
Article number 09 0131 68 12

illustration



scale drawing

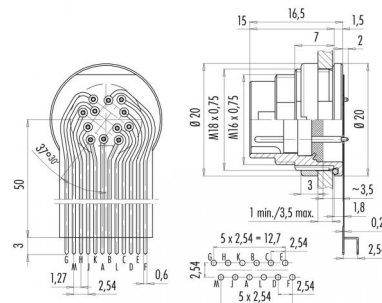

Contact Arrangement

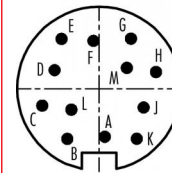

	X	Y
A	0,41	-3,45
B	-2,29	-3,61
C	-4,10	-1,21
D	-3,20	1,34
E	-2,71	3,59
F	-0,41	3,45
G	2,29	3,61
H	4,10	1,21
J	3,20	-1,34
K	2,71	-3,59
L	-2,00	-1,51
M	2,00	1,51

You can find the assembly instruction on the next page.

Technical data

Common values

Connector Design	Male socket
Connector locking system	Screw
Termination	dip solder
Wire gauge (mm)	-
Wire gauge (AWG)	-
Upper temperature	+95 °C
Lower temperature	-40 °C

Material

Material of contact	CuZn (brass)
Contact plating	Au (gold)
Material of contact body	PBT (UL 94 V-0)
Material of housing	zinc diecasting, nickel plated

Cable data

Contacts 12, male socket with flexible PCB, front fastened, gold plated contacts

Electrical values

Rated voltage	60 V
Rated impulse voltage	500 V
Pollution degree	1
Overvoltage category	I
Material group	III
Rated current (40°C)	3 A
Volume resistivity	≤ 3 mΩ
EMV compliance	shielded
Degree of protection	IP 67
Mechanical operation	>500 mating cycles



Product Flanschstecker mit Flexplatte, von vorn verschraubbar, vergoldete Kontakte, zweireihig
Area M16 connectors IP 67 serie 423/ 723/ 425

Pole 12
Article number 09 0131 68 12

Date: 2014-07-20 - Page 2 of 2

Installation instructions / Mounting cutout

